

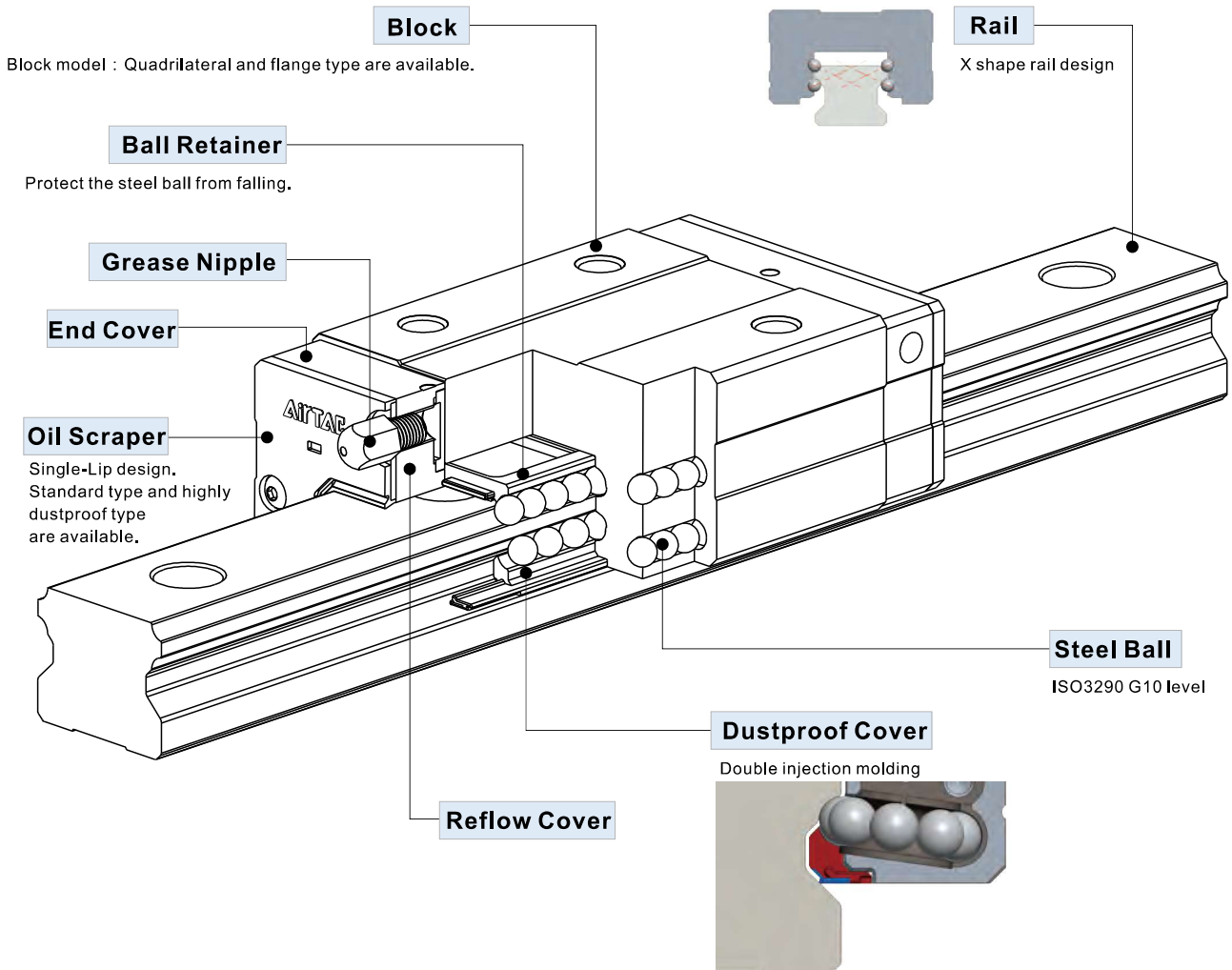

LSD Series Low Profile Type Linear Guide

Product Introduction



Product Features

1. With self-adjustment ability

X-shaped (45° - 45°) of curved groove on cross section design makes it self-aligning. Even small misalignment exists on the mounting surface, this design can help absorb it and maintain high precision, smooth and stable linear motion.

2. Low profile, High rigidity, equal load on four direction design

The 45-degree contact angle design of the four rows of steel balls and the raceway allow the steel balls to achieve the ideal two-point contact, and can withstand the action and reaction force from the radial and lateral direction. Meanwhile, pre-load can be applied to increase extra rigidity if necessary. Reduce the combined height of the slide block and the slide rail, shorten the length of the slide block, to achieve miniaturization.

3. Interchangeable

Because of the strict control on manufacturing process, the dimensional accuracy is stable and within the set tolerance.

Besides, the ball retainer design can prevent steel balls from falling out. Therefore when assembling, blocks are interchangeable within the same spec and still maintain consistency of pre-load and accuracy.



Low Profile Type Linear Guide

LSD Series



Order Information(Combined)

1、LSD15/30

LSD 15 H N 1 X220 S20 A H-U-AM6-B-T-□

① ② ③ ④ ⑤ ⑥ ⑦ ⑧ ⑨ ⑩ ⑪ ⑫ ⑬ ⑭

Standard margin pitch is 20mm.
Customer can define a non-standard margin pitch.

① Model Code	LSD:Low Profile Type Linear Guide			
② Rail Width	15:15mm 30:28mm			
③ Block Style	H: Square type F1: Flange type, Mounting from top F2: Flange type, Mounting from bottom F3: Flange type, Mounting from top or bottom			
④ Block type	S: Short N: Standard			
⑤ Number of Block	1: One 2: Two [Note: Amount of block on a single set of linear guide]			
⑥ Length of Rail	220:220mm[Defined by customer]			
⑦ Position of first mounting hole	S□ : Distance from end of rail to the center of first mounting hole (It is recommended to be greater than minimum margin) [Standard margin pitch is 20mm]			
⑧ Preload	A: Standard clearance B: Light Preload C: Medium Preload			
⑨ Accuracy	N : Normal H : High P : Precision			
⑩ Rail type	LSD15:Blank: Top-mount(M4)		LSD15:U: Top-mount(M3)	
	LSD30:Blank: Top-mount(M6)		LSD30:U: Top-mount(M8)	
⑪ Nipple /adapter type	LSD15: M4: M4 Nipple	LSD15: AM6: M4 to M6	LSD15: LM6: M4 to M6	LSD30: SM6: M6 Nipple
	LSD30: M6: M6 Nipple	LSD30: A01: M6 to PT1/8 LSD30: AM8: M6 to M8	LSD30: L01: M6 to PT1/8 LSD30: LM8: M6 to M8	
⑫ Packing type	Blank: the block and rail are assembled B: block and rail are put separately			
⑬ Rail type [Note]	Blank: Top-mount T: Bottom-mount			
⑭ Dust proof	Blank: Standard DD: Double oil scrapers ZZ: Oil scraper + metal scraper [Note 1]			

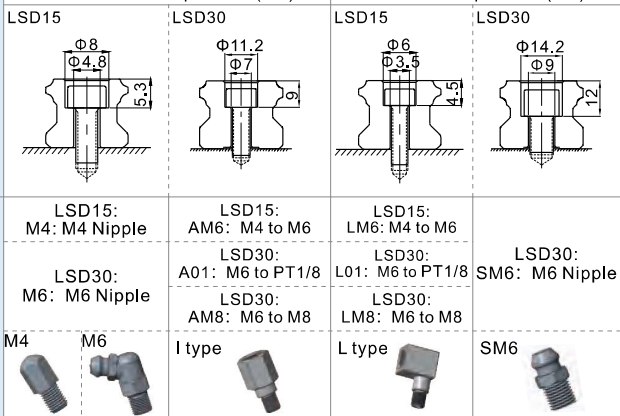

[Note1] Refer to P44 for highly dust proof type.

Add: Rail type indicated in ⑩ and ⑬ in ordering code cannot be selected at the same time, only one of them can be selected.





Low Profile Type Linear Guide

LSD Series

2、LSD20/25/35

LSD 20 H N 1 X220 S20 A H - AM8-B - T-□

① ② ③ ④ ⑤ ⑥ ⑦ ⑧ ⑨ ⑩ ⑪ ⑫ ⑬

① Model Code	LSD:Low Profile Type Linear Guide			
② Rail Width	20:20mm	25:23mm	35:34mm	
③ Block Style	H: Square type F1: Flange type, Mounting from top F2: Flange type, Mounting from bottom F3: Flange type, Mounting from top or bottom			
④ Block type	S: Short N: Standard			
⑤ Number of Block	1: One	2: Two [Note: Amount of block on a single set of linear guide]		
⑥ Length of Rail	220:220mm[Defined by customer]			
⑦ Position of first mounting hole	S□ : Distance from end of rail to the center of first mounting hole (It is recommended to be greater than minimum margin) [Standard margin pitch is 20mm]			
⑧ Preload	A: Standard clearance B: Light Preload C: Medium Preload			
⑨ Accuracy	N : Normal H : High P : Precision			
⑩ Nipple /adapter type	M6:M6 Nipple	A01:M6 to PT1/8 AM8:M6 to M8	L01:M6 to PT1/8 LM8:M6 to M8	SM6: M6 Nipple
		I type 	L type 	SM6 
⑪ Packing type	Blank: the block and rail are assembled B: block and rail are put separately			
⑫ Rail type	Blank: Top-mount T: Bottom-mount			
⑬ Dust proof	Blank: Standard DD: Double oil scrapers ZZ: Oil scraper + metal scraper [Note 1]			

Standard margin pitch is 20mm.
Customer can define a non-standard margin pitch.

[Note1] Refer to P44 for highly dust proof type.

Low Profile Type Linear Guide

LSD Series

Butt-jointed Order Information

1、LSD15/30

LSD 15 H N 1X3920 T 3900T3920 A H-U-AM6-B -T -□

① ② ③ ④ ⑤ ⑥ ⑦ ⑧ ⑨ ⑩ ⑪ ⑫ ⑬ ⑭ ⑮ ⑯ ⑰

Butt-jointed end margin:1/2P ,
Position of the first and last
hole is defined by customer.

① Model Code	LSD:Low Profile Type Linear Guide			
② Rail Width	15:15mm 30:28mm			
③ Block Style	H: Square type F1: Flange type, Mounting from top F2: Flange type, Mounting from bottom F3: Flange type, Mounting from top or bottom			
④ Block type	S: Short N: Standard			
⑤ Number of Block	1: One 2: Two [Note: Amount of block on a single set of linear guide]			
⑥ Length of first Rail	3920:3920mm[Defined by customer]			
⑦ Butt-jointed mark	T: Rail Butt-jointed mark(Butt-jointed end margin:1/2P) [P is the standard hole distance]			
⑧ Length of second Rail	3900:3900mm[Defined by customer]			
⑨ Butt-jointed mark	Blank: two rails joint T: Rail Butt-jointed mark (Butt-jointed end margin:1/2P) [P is the standard hole distance]			
⑩ Length of third Rail	Blank: two rails joint 3920:3920mm...[Defined by the customer]			
⑪ Preload	A: Standard clearance B: Light Preload C: Medium Preload			
⑫ Accuracy	N: Normal H: High			
⑬ Rail type	LSD15:Blank: Top-mount(M4)	LSD15:U: Top-mount(M3)		
	LSD30:Blank: Top-mount(M6)	LSD30:U: Top-mount(M8)		
	LSD15	LSD30	LSD15	LSD30
⑭ Nipple /adapter type	LSD15: M4: M4 Nipple	LSD15: AM6: M4 to M6	LSD15: LM6: M4 to M6	LSD30: SM6: M6 Nipple
	LSD30: M6: M6 Nipple	LSD30: A01: M6 to PT1/8 LSD30: AM8: M6 to M8	LSD30: L01: M6 to PT1/8 LSD30: LM8: M6 to M8	
⑮ Packing type	Blank: the block and rail are assembled B: block and rail are put separately			
⑯ Rail type [Add2]	Blank: Top-mount T: Bottom-mount			
⑰ Dust proof	Blank: Standard DD: Double oil scrapers ZZ: Oil scraper + metal scraper [Note 1]			

[Note1] Refer to P44 for highly dust proof type.

Add 1: Number of joints cannot be more than 2 times(three rails at most).

For LSD15, maximum length of jointed rail is 11800mm.

For LSD30, it's 11880.

Customization is needed for joint times more than standard.

Add 2: Rail type indicated in ⑬ and ⑭ in ordering code cannot be selected at the same time, only one of them can be selected.

Low Profile Type Linear Guide







LSD Series

2. LSD20/25/35

LSD 20 H N 1X3920T3900T3920A H-AM8-B-T-□

- ①
- ②
- ③
- ④
- ⑤
- ⑥
- ⑦
- ⑧
- ⑨
- ⑩
- ⑪
- ⑫
- ⑬
- ⑭
- ⑮
- ⑯

Butt-jointed end margin:1/2P ,
Position of the first and last
hole is defined by customer.

① Model Code	LSD:Low Profile Type Linear Guide			
② Rail Width	20:20mm 25:23mm 35:34mm			
③ Block Style	H: Square type F1: Flange type, Mounting from top F2: Flange type, Mounting from bottom F3: Flange type, Mounting from top or bottom			
④ Block type	S: Short N: Standard			
⑤ Number of Block	1: One 2: Two [Note: Amount of block on a single set of linear guide]			
⑥ Length of first Rail	3920:3920mm[Defined by customer]			
⑦ Butt-jointed mark	T: Rail Butt-jointed mark (Butt-jointed end margin:1/2P) [P is the standard hole distance]			
⑧ Length of second Rail	3900:3900mm[Defined by customer]			
⑨ Butt-jointed mark	Blank: two rails joint T: Rail Butt-jointed mark (Butt-jointed end margin:1/2P) [P is the standard hole distance]			
⑩ Length of third Rail	Blank: two rails joint 3920:3920mm..[Defined by the customer]			
⑪ Preload	A: Standard clearance B: Light Preload C: Medium Preload			
⑫ Accuracy	N : Normal H : High			
⑬ Nipple /adapter type	M6: M6 Nipple	A01: M6 to PT1/8 AM8: M6 to M8	L01: M6 to PT1/8 LM8: M6 to M8	SM6: M6 Nipple
		I type 	L type 	SM6 
⑭ Packing type	Blank: the block and rail are assembled B: block and rail are put separately			
⑮ Rail type	Blank: Top-mount T: Bottom-mount			
⑯ Dust proof	Blank: Standard DD: Double oil scrapers ZZ: Oil scraper + metal scraper [Note 1]			

[Note1] Refer to P44 for highly dust proof type.
Add: Number of joints cannot be more than 2 times(three rails at most).
For LSD20/25, maximum length of jointed rail is 11800mm.
For LSD35, it's 11880.
Customization is needed for joint times more than standard.

Low Profile Type Linear Guide

LSD Series

1. Block Order Information

LSD 15 BK - H N - H - D - AM6 - □

[Note1] When selecting rails and bearings, the different pairing codes can change the units preload, details see "preload pairing chart".
 [Note2] Refer to P44 for highly dust proof type.



① Model Code	LSD:Low Profile Type Linear Guide							
② Rail Width	15:15mm	20:20mm	25:23mm	30:28mm	35:34mm			
③ Block Code	BK: Block							
④ Block Style	H: Square type F1: Flange type, Mounting from top F2: Flange type, Mounting from bottom F3: Flange type, Mounting from top or bottom							
⑤ Block type	S: Short N: Standard							
⑥ Accuracy	N : Normal H : High							
⑦ Group code	SC SB B D [Note1]							
⑧ Nipple /adapter type	15	M4	M4 Nipple		M6	M6 Nipple		
		AM6	M4 to M6	I type	20	A01	M6 to PT1/8	I type
				L type	30	AM8	M6 to M8	
		LM6	M4 to M6		35	L01	M6 to PT1/8	L type
⑨ Dust proof	Blank: Standard DD: Double oil scrapers ZZ: Oil scraper + metal scraper [Note 2]							

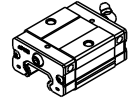

S: Short

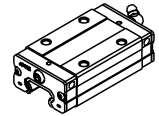

N: Standard

2. Rail(4m) Order Information

(1) LSD15/30

LSD 15 RL X 4000 - H - D - U



① Model Code	LSD:Low Profile Type Linear Guide		
② Rail Width	15:15mm 30:28mm		
③ Rail Code	RL: Rail		
④ Rail Length	4000 : 4000mm		
⑤ Accuracy	N : Normal H : High		
⑥ Group code	D [Note]		
⑦ Rail type	LSD15: Blank: Top-mount(M4)	LSD15: U: Top-mount(M3)	T: Bottom-mount
	LSD30: Blank: Top-mount(M6)	LSD30: U: Top-mount(M8)	
	LSD15	LSD30	LSD15

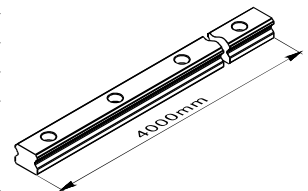

Note: • Standard length of LSD rail is four meters.

- For LSD15, both margin pitch of rail are 20mm. For LSD30, one side of margin pitch is 20mm, the other side is 60mm.
- When selecting rails and bearings, the different pairing codes can change the units preload, details see "preload pairing chart".

(2) LSD20/25/35

LSD 20 RL X 4000- H - D - T



① Model Code	LSD:Low Profile Type Linear Guide		
② Rail Width	20:20mm 25:23mm 35:34mm		
③ Rail Code	RL: Rail		
④ Rail Length	4000 : 4000mm		
⑤ Accuracy	N : Normal H : High		
⑥ Group Code	D [Note]		
⑦ Rail type	Blank: Top-mount T: Bottom-mount		

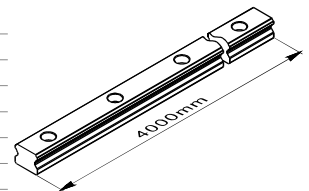

Note: • Standard length of LSD rail is four meters.

- For LSD20/25, both margin pitch of rail are 20mm.
- For LSD35, one side of margin pitch is 20mm, the other side is 60mm.
- When selecting rails and bearings, the different pairing codes can change the units preload, details see "preload pairing chart".

Low Profile Type Linear Guide

LSD Series

3. Rail Order Information

(1) LSD15/30

LSD 15 RL X 220-S20 - H - D - U

Note: When selecting rails and bearings, the different pairing codes can change the units preload, details see "preload pairing chart".



① Model Code	LSD: Low Profile Type Linear Guide			
② Rail Width	15: 15mm 30: 28mm			
③ Rail Code	RL: Rail			
④ Rail Length	220: 220mm [Defined by customer]			
⑤ Position of first mounting hole	S □ : Distance from end of rail to the center of first mounting hole (It is recommended to be greater than minimum margin) [Standard margin pitch is 20mm]			
⑥ Accuracy	N : Normal H : High			
⑦ Group code	D [Note]			
⑧ Rail type	LSD15: Blank: Top-mount (M4)		LSD15: U: Top-mount (M3)	
	LSD30: Blank: Top-mount (M6)		LSD30: U: Top-mount (M8)	
	LSD15		LSD30	
	LSD15		LSD30	
T: Bottom-mount				

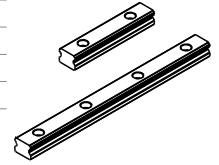

Standard margin pitch is 20mm.
Customer can define a non-standard margin pitch.

(2) LSD20/25/35

LSD 20 RL X 220-S20 - H - D - T

Note: When selecting rails and bearings, the different pairing codes can change the units preload, details see "preload pairing chart".



① Model Code	LSD: Low Profile Type Linear Guide			
② Rail Width	20: 20mm 25: 23mm 35: 34mm			
③ Rail Code	RL: Rail			
④ Rail Length	220: 220mm [Defined by customer]			
⑤ Position of first mounting hole	S □ : Distance from end of rail to the center of first mounting hole (It is recommended to be greater than minimum margin) [Standard margin pitch is 20mm]			
⑥ Accuracy	N : Normal H : High			
⑦ Group code	D [Note]			
⑧ Rail type	Blank: Top-mount T: Bottom-mount			

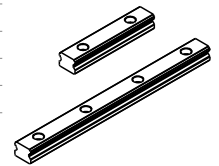

Standard margin pitch is 20mm.
Customer can define a non-standard margin pitch.

4. Rail/Block preload pairing chart

When customer orders rail/block, please choose the pairing code of rail/block in accordance with the needed preload of linear guide (combined). Details please refer to the "preload pairing chart".

Model	Rail pairing code	Block pairing code	Preload grade	Model	Rail pairing code	Block pairing code	Preload grade	
LSD15	D	D	Standard clearance	LSD35	D	D	Standard clearance	
LSD20		B	Light preload			B	Light preload	
LSD25		SB	SB			Medium preload	SC	Medium preload
LSD30								

Accessory Order Code

L - P - AM6 - □



Note: For adapter assembly, no need to select this code (It can be applied for both standard and dustproof type block)

① Accessory Code	L: Linear Guide Accessory							
② Nipple/adaptor Code	P: Nipple/adaptor							
③ Nipple/adaptor type	15	M4	M4 Nipple		20 25 30	M6	M6 Nipple	
		AM6	M4 to M6	I type		A01	M6 to PT1/8	I type
	35	LM6	M4 to M6	L type	L01	M6 to PT1/8	L type	
					SM6	M6 to M8	L type	
④ Block type [Note]	Blank: Standard ZZ: For LSD15/25/30/35 series highly dustproof block (both DD and ZZ type) ZZLSD20: For LSD20 series highly dustproof block (both DD and ZZ type)							

Low Profile Type Linear Guide

LSD Series

Rail Specification

The edge pitch of first mounting hole (S) and last mounting hole (E) should not be greater than 1/2P. Overlong edge may induce unstable installation and affect the accuracy.

n: Numbers of mounting holes

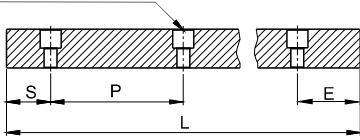

$$L = (n-1) \times P + S + E$$

L: Total length of rail(mm)

n: Numbers of mounting holes on rail

P: Distance between bolt holes(mm)

S: Edge of first mounting hole(mm)

E: Edge of last mounting hole(mm)

Model	LSD15	LSD20	LSD25	LSD30	LSD35
Pitch(P)	60	60	60	80	80
Standard Edge pitch(S)	20	20	20	20	20
Min. Edge Pitch(S/E min)	5(4)	6	7	7(8)	8
Max. Edge Pitch(S/E max)	55(56)	54	53	73(72)	72
Maximum length of rail for standard edge	4000	4000	4000	3960	3960
Maximum length(Lmax)	4000	4000	4000	4000	4000

Note:

- For LSD15 when it mounted with M3 screw, Min.edge pitch is 4mm, Max.edge pitch is 56mm. For LSD15 when it mounted with M4 screw, Min.edge pitch is 5mm, Max. edge pitch is 55mm.
- For LSD30 when it mounted with M6 screw, Min.edge pitch is 7mm, Max.edge pitch is 73mm. For LSD30 when it mounted with M8 screw, Min.edge pitch is 8mm, Max. edge pitch is 72mm.
- Joint rail must be chosen if length of rail exceeds the maximum.
- When deciding edge pitch, it should be within the range of above table. There would be risk of broken hole if pitch is out of range.
- Maximum length of rail for standard' means the maximum length of rail can be chosen when both sides of edge pitches are standard.

Specifications and Dimensions

Square type

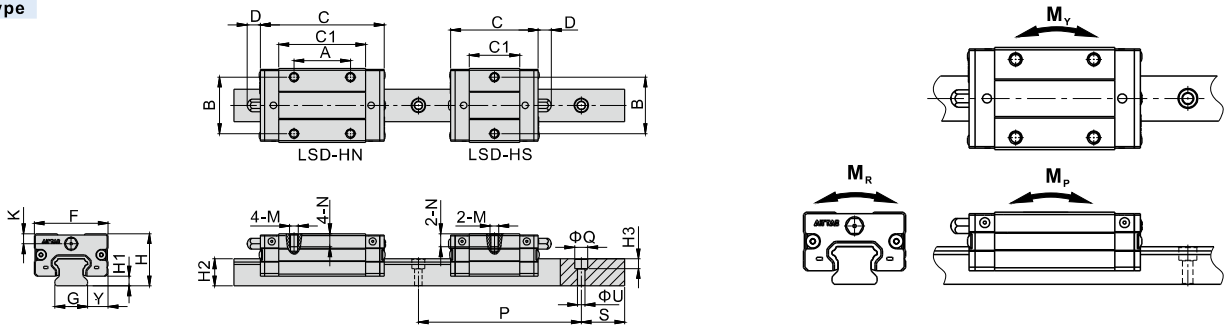

Model/Item	External Dimension (mm)				Block Dimension (mm)							Rail Dimension (mm)									
	H	H1	F	Y	C			C1	A	B	K	D	M	N	G	H2	P	S	ΦQ[Note]	ΦU	H3
LSD15HS	24	4.5	34	9.5	40.5	47.5	45	23.5	-	26	4.6	6	M4X0.7	6	15	12.5	60	20	8(6)	4.8(3.5)	5.3(4.5)
LSD15HN	24	4.5	34	9.5	57	64	61.5	40	26	26	4.6	6	M4X0.7	6	15	12.5	60	20	8(6)	4.8(3.5)	5.3(4.5)
LSD20HS	28	6	42	11	46	53	50.5	29	-	32	6.2	13	M5X0.8	7	20	15.5	60	20	9.5	5.8	8.5
LSD20HN	28	6	42	11	65	72	69.5	48	32	32	6.2	13	M5X0.8	7	20	15.5	60	20	9.5	5.8	8.5
LSD25HS	33	7	48	12.5	59	66	63.5	36.5	-	35	7.2	13	M6X1.0	9	23	18	60	20	11.2	7	9
LSD25HN	33	7	48	12.5	83	90	87.5	60.5	35	35	7.2	13	M6X1.0	9	23	18	60	20	11.2	7	9
LSD30HS	42	9	60	16	68.5	76.5	73.5	41.5	-	40	7.2	13	M8X1.25	12	28	23	80	20	11.2(14.2)	7(9)	9(12)
LSD30HN	42	9	60	16	97	105	102	70	40	40	7.2	13	M8X1.25	12	28	23	80	20	11.2(14.2)	7(9)	9(12)
LSD35HS	48	11	70	18	73.5	81.5	78.5	46.5	-	50	8.5	13	M8X1.25	12	34	27.5	80	20	14.2	9	12
LSD35HN	48	11	70	18	106.5	114.5	111.5	79.5	50	50	8.5	13	M8X1.25	12	34	27.5	80	20	14.2	9	12

Model/Item	Mounting Screw	Dynamic Load Rating(kN)		Static Load Rating(kN)		Static Rated Moment (kN.m)			Weight	
		C	C ₀	C ₀	C ₀	M _x	M _y	M _z	Block(kg)	Rail(kg/m)
LSD15HS	M4(M3)	5.0	9.5	0.07	0.04	0.04	0.09	1.23		
LSD15HN	M4(M3)	8.9	16.5	0.12	0.10	0.10	0.15	1.23		
LSD20HS	M5	7.2	13.5	0.13	0.06	0.06	0.14	2.11		
LSD20HN	M5	12.1	22.4	0.20	0.15	0.15	0.23	2.11		
LSD25HS	M6	11.5	20.8	0.22	0.11	0.11	0.26	2.76		
LSD25HN	M6	19.3	34.7	0.36	0.31	0.31	0.42	2.76		
LSD30HS	M6(M8)	19.8	30.0	0.38	0.20	0.20	0.44	4.60		
LSD30HN	M6(M8)	28.3	50.3	0.65	0.53	0.53	0.75	4.60		
LSD35HS	M8	29.2	40.7	0.66	0.33	0.33	0.74	6.27		
LSD35HN	M8	42.7	70.2	1.02	0.72	0.72	1.17	6.27		

[Note]: The standard countersink of LSD15 rail is Φ8X5.3XΦ4.8 and with M4 screw. If with M3 screw, the ordering code should add "U", and the countersink is Φ6X4.5XΦ3.5. The standard countersink of LSD30 rail is Φ11.2X9XΦ7 and with M6 screw. If with M8 screw, the ordering code should add "U", and the countersink is Φ14.2X12XΦ9.

Low Profile Type Linear Guide

LSD Series

Flange type, Top-Mount

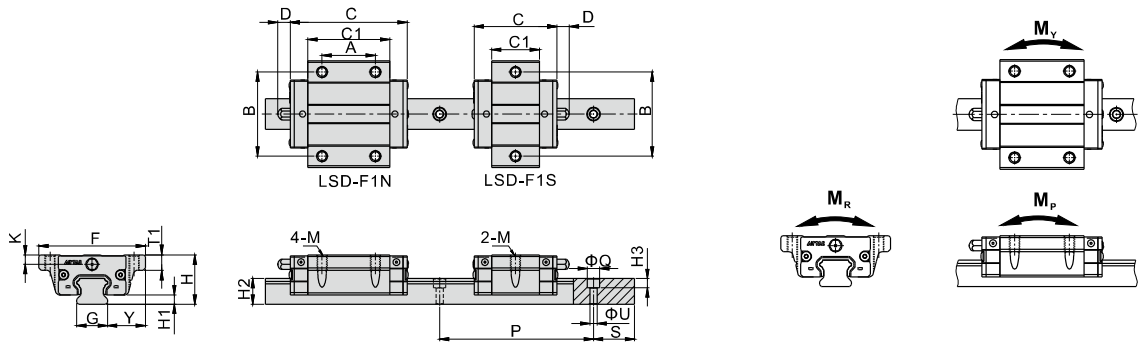

Model\Item	External Dimension (mm)							Block Dimension (mm)							Rail Dimension (mm)						
	H	H1	F	Y	C			C1	A	B	K	D	M	T1	G	H2	P	S	ΦQ[Note]	ΦU	H3
LSD15F1S	24	4.5	52	18.5	40.5	47.5	45	23.5	-	41	4.6	6	M5X0.8	7.5	15	12.5	60	20	8(6)	4.8(3.5)	5.3(4.5)
LSD15F1N	24	4.5	52	18.5	57	64	61.5	40	26	41	4.6	6	M5X0.8	7.5	15	12.5	60	20	8(6)	4.8(3.5)	5.3(4.5)
LSD20F1S	28	6	59	19.5	46	53	50.5	29	-	49	6.2	13	M6X1.0	9.5	20	15.5	60	20	9.5	5.8	8.5
LSD20F1N	28	6	59	19.5	65	72	69.5	48	32	49	6.2	13	M6X1.0	9.5	20	15.5	60	20	9.5	5.8	8.5
LSD25F1S	33	7	73	25	59	66	63.5	36.5	-	60	7.2	13	M8X1.25	10.5	23	18	60	20	11.2	7	9
LSD25F1N	33	7	73	25	83	90	87.5	60.5	35	60	7.2	13	M8X1.25	10.5	23	18	60	20	11.2	7	9
LSD30F1S	42	9	90	31	68.5	76.5	73.5	41.5	-	72	7.2	13	M10X1.5	10.5	28	23	80	20	11.2(14.2)	7(9)	9(12)
LSD30F1N	42	9	90	31	97	105	102	70	40	72	7.2	13	M10X1.5	10.5	28	23	80	20	11.2(14.2)	7(9)	9(12)
LSD35F1S	48	11	100	33	73.5	81.5	78.5	46.5	-	82	8.5	13	M10X1.5	13.5	34	27.5	80	20	14.2	9	12
LSD35F1N	48	11	100	33	106.5	114.5	111.5	79.5	50	82	8.5	13	M10X1.5	13.5	34	27.5	80	20	14.2	9	12

Model\Item	Mounting Screw	Dynamic Load Rating(kN)	Static Load Rating(kN)	Static Rated Moment (kN.m)			Weight			
				C	C ₀	M _R	M _P	M _V	Block(kg)	Rail(kg/m)
LSD15F1S	M4(M3)	5.0	9.5	5.0	9.5	0.07	0.04	0.04	0.12	1.23
LSD15F1N	M4(M3)	8.9	16.5	8.9	16.5	0.12	0.10	0.10	0.21	1.23
LSD20F1S	M5	7.2	13.5	7.2	13.5	0.13	0.06	0.06	0.18	2.11
LSD20F1N	M5	12.1	22.4	12.1	22.4	0.20	0.15	0.15	0.31	2.11
LSD25F1S	M6	11.5	20.8	11.5	20.8	0.22	0.11	0.11	0.36	2.76
LSD25F1N	M6	19.3	34.7	19.3	34.7	0.36	0.31	0.31	0.60	2.76
LSD30F1S	M6(M8)	19.8	30.0	19.8	30.0	0.38	0.20	0.20	0.61	4.60
LSD30F1N	M6(M8)	28.3	50.3	28.3	50.3	0.65	0.53	0.53	1.03	4.60
LSD35F1S	M8	29.2	40.7	29.2	40.7	0.66	0.33	0.33	0.93	6.27
LSD35F1N	M8	42.7	70.2	42.7	70.2	1.02	0.72	0.72	1.50	6.27

[Note]: The standard countersink of LSD15 rail is $\Phi 8 \times 5.3 \times \Phi 4.8$ and with M4 screw. If with M3 screw, the ordering code should add "U", and the countersink is $\Phi 6 \times 4.5 \times \Phi 3.5$. The standard countersink of LSD30 rail is $\Phi 11.2 \times 9 \times \Phi 7$ and with M6 screw. If with M8 screw, the ordering code should add "U", and the countersink is $\Phi 14.2 \times 12 \times \Phi 9$.

Low Profile Type Linear Guide

LSD Series

Flange type, Bottom-Mount

Flange type, Top or Bottom-Mount

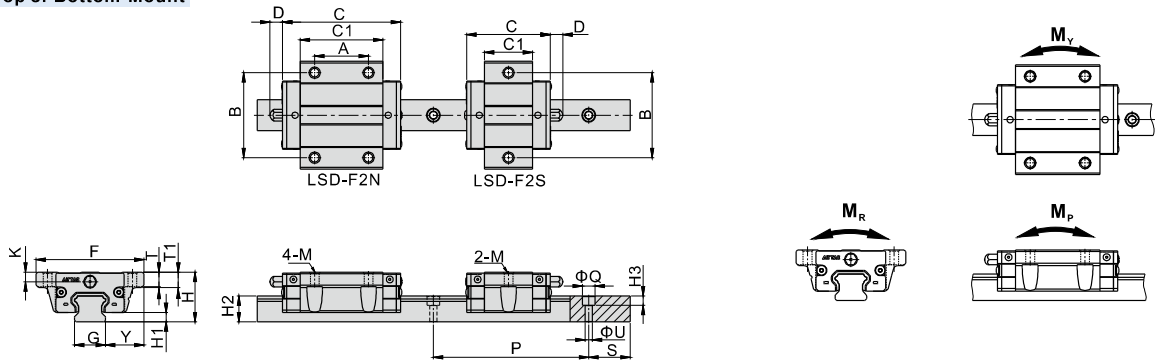

Model/Item	External Dimension (mm)							Block Dimension (mm)							Rail Dimension (mm)								
	H	H1	F	Y	C			C1	A	B	K	D	M		T	T1	G	H2	P	S	ΦQ [Note]	ΦU [Note]	H3 [Note]
					Standard (Blank)	Double oil scrapers (DD)	Oil scraper + Metal scraper (ZZ)						Bottom-Mount	Top or Bottom-Mount									
LSD15F2(F3)S	24	4.5	52	18.5	40.5	47.5	45	23.5	-	41	4.6	6	Φ4.5	M5X0.8	7	7.5	15	12.5	60	20	8(6)	4.8(3.5)	5.3(4.5)
LSD15F2(F3)N	24	4.5	52	18.5	57	64	61.5	40	26	41	4.6	6	Φ4.5	M5X0.8	7	7.5	15	12.5	60	20	8(6)	4.8(3.5)	5.3(4.5)
LSD20F2(F3)S	28	6	59	19.5	46	53	50.5	29	-	49	6.2	13	Φ5.7	M6X1.0	9	9.5	20	15.5	60	20	9.5	5.8	8.5
LSD20F2(F3)N	28	6	59	19.5	65	72	69.5	48	32	49	6.2	13	Φ5.7	M6X1.0	9	9.5	20	15.5	60	20	9.5	5.8	8.5
LSD25F2(F3)S	33	7	73	25	59	66	63.5	36.5	-	60	7.2	13	Φ6.8	M8X1.25	10	10.5	23	18	60	20	11.2	7	9
LSD25F2(F3)N	33	7	73	25	83	90	87.5	60.5	35	60	7.2	13	Φ6.8	M8X1.25	10	10.5	23	18	60	20	11.2	7	9
LSD30F2(F3)S	42	9	90	31	68.5	76.5	79.5	41.5	-	72	7.2	13	Φ9	M10X1.5	10	10.5	28	23	80	20	11.2(14.2)	7(9)	9(12)
LSD30F2(F3)N	42	9	90	31	97	105	102	70	40	72	7.2	13	Φ9	M10X1.5	10	10.5	28	23	80	20	11.2(14.2)	7(9)	9(12)
LSD35F2(F3)S	48	11	100	33	73.5	81.5	78.5	46.5	-	82	8.5	13	Φ9	M10X1.5	13	13.5	34	27.5	80	20	14.2	9	12
LSD35F2(F3)N	48	11	100	33	106.5	114.5	111.5	79.5	50	82	8.5	13	Φ9	M10X1.5	13	13.5	34	27.5	80	20	14.2	9	12

Model/Item	Mounting Screw	Dynamic Load Rating(kN)	Static Load Rating(kN)	Static Rated Moment (kN.m)			Weight	
				C ₀	M _r	M _p	M _v	Block(kg)
LSD15F2(F3)S	M4(M3)	5.0	9.5	0.07	0.04	0.04	0.12	1.23
LSD15F2(F3)N	M4(M3)	8.9	16.5	0.12	0.10	0.10	0.21	1.23
LSD20F2(F3)S	M5	7.2	13.5	0.13	0.06	0.06	0.18	2.11
LSD20F2(F3)N	M5	12.1	22.4	0.20	0.15	0.15	0.31	2.11
LSD25F2(F3)S	M6	11.5	20.8	0.22	0.11	0.11	0.36	2.76
LSD25F2(F3)N	M6	19.3	34.7	0.36	0.31	0.31	0.60	2.76
LSD30F2(F3)S	M6(M8)	19.8	30.0	0.38	0.20	0.20	0.61	4.60
LSD30F2(F3)N	M6(M8)	28.3	50.3	0.65	0.53	0.53	1.03	4.60
LSD35F2(F3)S	M8	29.2	40.7	0.66	0.33	0.33	0.93	6.27
LSD35F2(F3)N	M8	42.7	70.2	1.02	0.72	0.72	1.50	6.27

[Note]: The standard countersink of LSD15 rail is Φ8X5.3XΦ4.8 and with M4 screw. If with M3 screw, the ordering code should add "U", and the countersink is Φ6X4.5XΦ3.5. The standard countersink of LSD30 rail is Φ11.2X9XΦ7 and with M6 screw. If with M8 screw, the ordering code should add "U", and the countersink is Φ14.2X12XΦ9.

Low Profile Type Linear Guide

LSD Series

Dimension of bottom-mount type rail

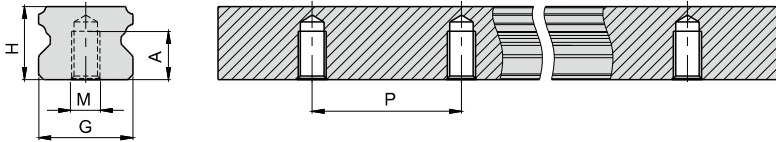

Model\Item	G	H	M	A	P
LSD15T	15	12.5	M5X0.8	7	60
LSD20T	20	15.5	M6X1.0	9	60
LSD25T	23	18	M6X1.0	10	60
LSD30T	28	23	M8X1.25	14	80
LSD35T	34	27.5	M8X1.25	17	80

Accuracy Classes

LSD Low Profile type linear guide comes with 3 accuracy levels.

Table 1 : Parallelism of the raceway

Accuracy	Accuracy Standards (mm)						Rail Length(mm)	Parallelism of the raceway(μm)		
	N : Normal		H: High		P: Precision			N	H	P
	Model	15/20	25/30/35	15/20	25/30/35	15/20				
Tolerance of height H	±0.1		±0.03	±0.04	±0.015	±0.02	100 under	12	7	3
Variation of height ΔH	0.02	0.025	0.01	0.015	0.006	0.007	100~200	14	9	4
							200~300	15	10	5
							300~500	17	12	6
Tolerance of width Y	±0.1		±0.03	±0.04	±0.015	±0.02	500~700	20	13	7
Variation of width ΔY	0.02	0.03	0.01	0.015	0.006	0.007	700~900	22	15	8
							900~1100	24	16	9
							1100~1500	26	18	11
Parallelism of C-surface relative to A-surface	Parallelism of raceway (Refer to Table 1)						1500~1900	28	20	13
Parallelism of D-surface relative to B-surface	Parallelism of raceway (Refer to Table 1)						1900~2500	31	22	15
							2500~3100	33	25	18
							3100~3600	36	27	20
							3600~4000	37	28	21

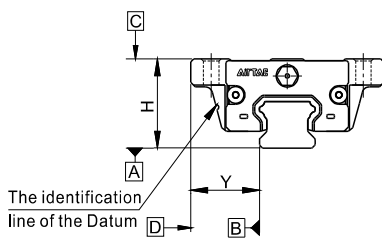

Preload Level

1. Preload interference

The LSD Low Profile type Linear Guide has three preload categories: A, B and C.

Choosing suitable preload level will enhance rigidity, precision and torsion resistant performance of the linear guide.

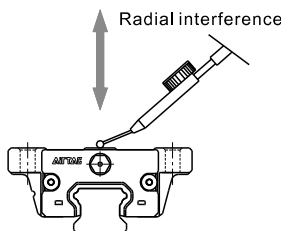

Model	Radial interference(μm)		
	Standard clearance(A)	Light Preload(B)	Middle Preload(C)
LSD15	-4~+2	-12~-4	-22~-14
LSD20	-5~+2	-13~-5	-23~-15
LSD25	-6~+2	-14~-6	-24~-16
LSD30	-7~+2	-16~-7	-29~-20
LSD35	-8~+2	-21~-11	-34~-24

2. Common Application

Refer to following table for suitable application of different preload grade:

Preload grade	Requirement	Common Application
Standard clearance(A)	One axial movement, small vibration and impact, accuracy requirement is low	Conveyor Machine, Semiconductor Equipment, Stage Equipment, Press Machine, Welding Machine and other light movement equipments
Light Preload(B)	Equipment that requires light-load and high-precision.	Z-axis movement for industrial use, NC lathe, EDM, Precision XY platform, Vertical machine center, measurement instrument, material feeder or industrial robot
Medium Preload(C)	Equipment that requires high rigidity, large vibration and shock.	Machining centers, NC lathes, grinders, vertical or horizontal milling machines, boring machines, tool guides, heavy cutting machines.

Low Profile Type Linear Guide

LSD Series

Installation Illustration

1. Allowable tolerance of mounting surface

LSD series is an arc-shape, two-point contact design of linear guide. Its self-centering feature allows some tolerance on mounting surface without affecting the smoothness of linear motion. The allowable tolerance is indicated in following table:

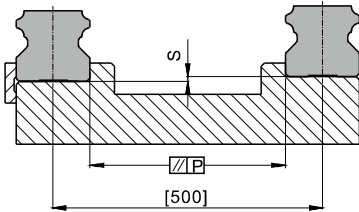

Model	Allowable tolerance of parallelism P(μm)			Allowable tolerance of top and bottom S (μm)		
	Standard clearance(A)	Light Preload(B)	Medium Preload(C)	Standard clearance(A)	Light Preload(B)	Medium Preload(C)
LSD15	25	18	-	130	85	-
LSD20	25	20	18	130	85	50
LSD25	30	22	20	130	85	70
LSD30	40	30	27	170	110	90
LSD35	50	35	30	210	150	120

Note: The value in the table is the allowable value when the distance between the two linear guides is 500mm, and the allowable value is proportional to the distance between the two linear guides.

2. Height and Chamfer of Reference Edge

In order to ensure accurate installation of LSD Linear Guide, the contact space should not exceed the given figures in following table.

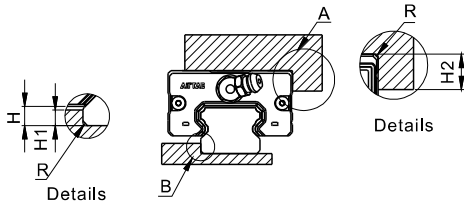

Unit : mm

Model	H	H1	H2	R(Max)
LSD15	4.5	2.7	5	0.5
LSD20	6	5	7	0.5
LSD25	7	5	7.5	1
LSD30	9	7	7	1
LSD35	11	7.5	9.5	1

3. Screw Tighten Torque

When installing linear guide, whether the screws are well tighten and surface is well contacted will affect accuracy significantly. Please refer to following table for tightening force to ensure a perfect installation.

Model	Screw size	Tighten Torque(N.cm)		
		Iron	Casting	Aluminum alloy
LSD15	M3	196	127	98
	M4	412	274	206
LSD20	M5	882	588	441
LSD25	M6	1370	921	686
LSD30	M6	1370	921	686
	M8	3040	2010	1470
LSD35	M8	3040	2010	1470

4. Installation and Application

Linear guide installation methods can be divided into the followings. For installations other than forward installation, the lubricant may fail.

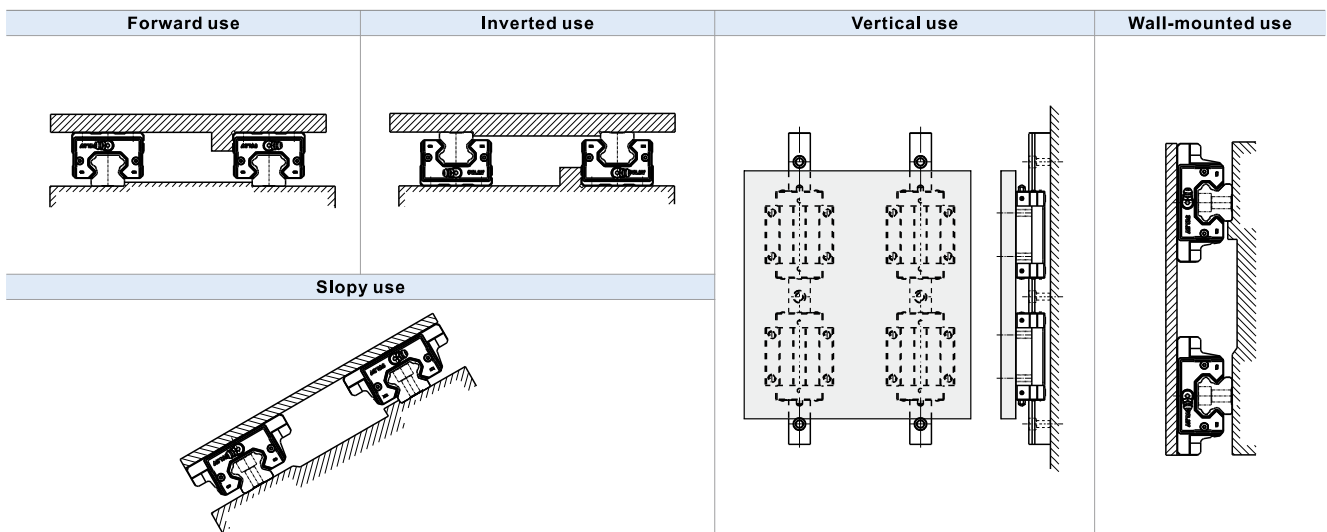

Low Profile Type Linear Guide

LSD Series

5. Datum plane

- Datum plane for installation must be ground or finely milled to ensure accuracy.
- Both sides of Rail can be used as the datum plane.
- For multi-blocks on a rail, identification line on blocks should be put on the same side to ensure moving accuracy.

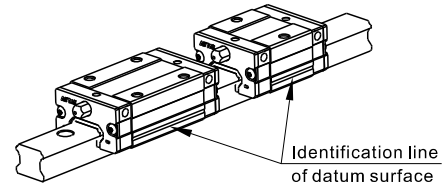

6. Fixation Method

Rails and blocks are possible to be displaced while the machine is subjected to vibrations and impacts thus to affect the accuracy. In order to avoid those difficulties and achieve high running accuracy, the following four methods are recommended for fixing.

Mounting with a plate	Mounting with screw	Mounting with taper	Mounting with needle roller

7. Rail Installation

A. Before installing the rail, remove all dirt from the mounting surface with oil stone, and then wipe with a clean cloth.

Remove all dirt from the mounting surface with oil stone, and then wipe with a clean cloth

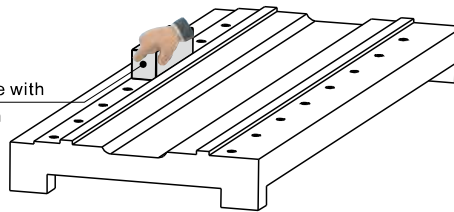

B. Place the rail gently on the bed firstly, then put the bolts into the mounting holes and pre-tighten them, place the rail ① into close contact with the datum plane of the bed by using the baffle, tighten the bolts with appropriate torque to fix the rail. Refer to "3. Screw tighten torque" for recommended torque value.

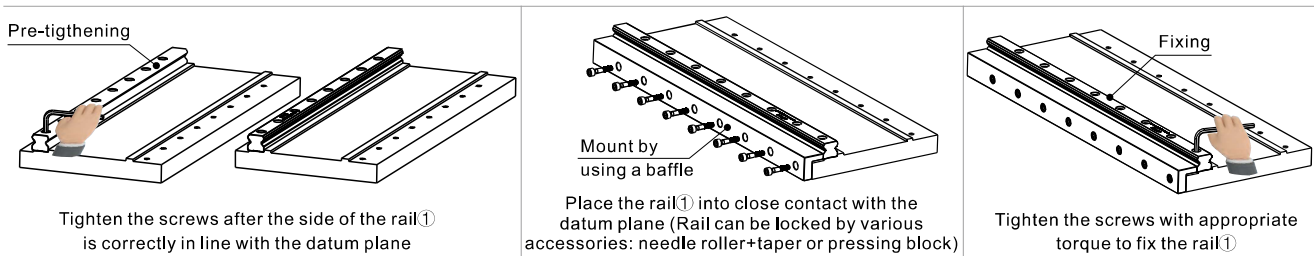

8. Block Installation

- Temporarily fix the table on the block by using the mounting bolts.
- Push the block datum plane against the side datum plane of the table and position the block by tightening the set screws.
- Tighten the mounting bolts in 1 to 4 sequences to fix the table on the block.

9. Subsidiary Rail Installation

Under the condition that the subsidiary rail has a reference datum plane, remove all dirt from the mounting surface with oil stone, and then wipe with a clean cloth, mount the subsidiary rail ② with the same method of the master rail ①.

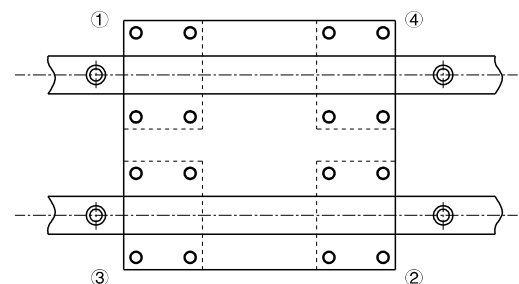
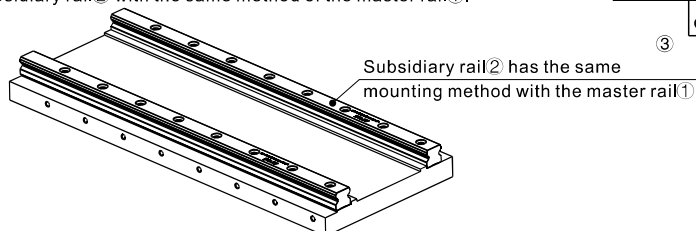

Under the condition that the subsidiary rail ② has a reference datum plane, remove all dirt from the mounting surface with oil stone, and then wipe with a clean cloth,

Low Profile Type Linear Guide

LSD Series

10. Rail Installation without Side Datum Surface

Using a provisional datum plane

Use the datum plane provided on the bed for straight alignment of the rail from one end to the other, attention must be paid to fix two blocks in close contact on the measuring plate.

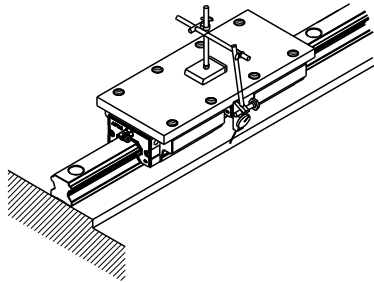

Using a straight-edge

Put the straight-edge between the two rails and use a dial gauge to adjust straight-edge in parallel with the side datum plane of the master rail. Use the dial gauge to ensure the straightness of the subsidiary rail by using the straight-edge as reference, then tighten the mounting bolts in proper sequence when the subsidiary rail is parallel to the master rail.

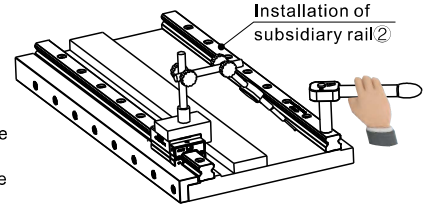

11. Rail Installation without Set Screws

To ensure parallelism between the subsidiary rail and the master rail in the condition without set screws, the following installation methods are recommended, and the installation of the block is the same as mentioned previously.

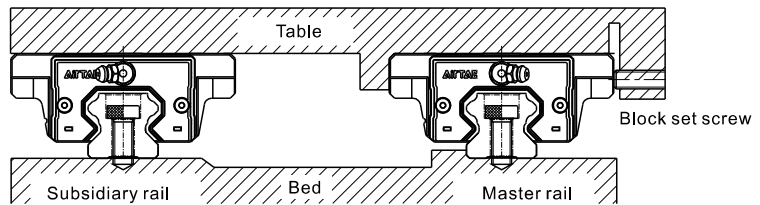

Installation of the master rail

Using a vice

Put the rail on the bed mounting surface and temporarily fasten the mounting bolts, then push the rail against the side datum plane of the bed by using a vice to ensure the rail position. Tighten the mounting bolts in proper sequence with specific torque.

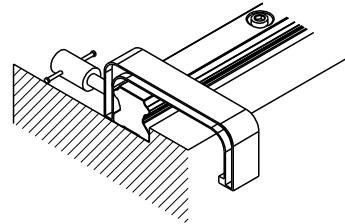

Installation of the subsidiary rail

Using a straight-edge

Put the straight-edge between the two rails and use a dial gauge to adjust straight-edge in parallel with the side datum plane of the master rail. Use the straight-edge to ensure the straightness of the subsidiary rail, then tighten the mounting bolts in proper sequence with specific torque.

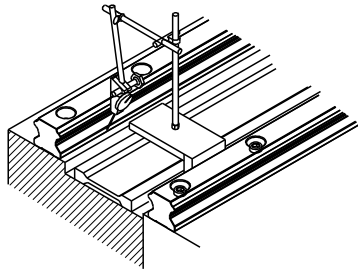

Using a table

Fix two blocks on the master rail to the table, and temporarily fix the subsidiary rail to the bed and one block on the subsidiary rail to the table. Place the gauge against the side surface of the block on the subsidiary rail, move the table from one end of the rail to the other end, then tighten the mounting bolts in proper sequence with specific torque while aligning the subsidiary rail parallel to the master rail.

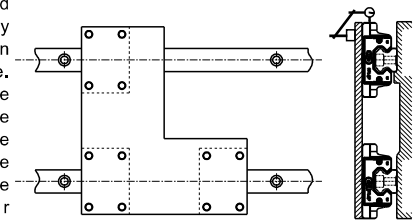

Following the master rail

Fix the table to the two blocks on the master rail and one of the two blocks on the subsidiary rail, temporarily fix the other block on the subsidiary rail to the table and subsidiary rail to the bed. Moving the table from one end of the master rail and tighten the mounting bolts on the subsidiary rail in proper sequence with specific torque at the same time.

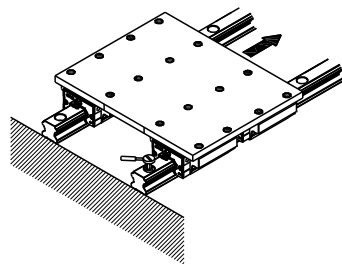

Using a jig

Use a special jig to help ensure the position of the subsidiary rail, and tighten the mounting bolts in proper sequence with specific torque.

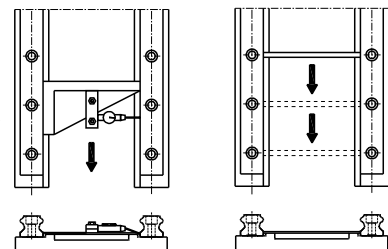

LSD Series

12. Rail Butt-jointed

- When it comes to butt-jointed rail installation, it must follow the butt-jointed marks shown below.
- In order to avoid the accuracy caused by installing the matched jointed rails, it is recommended to stagger the butt-jointed positions, see figure below.

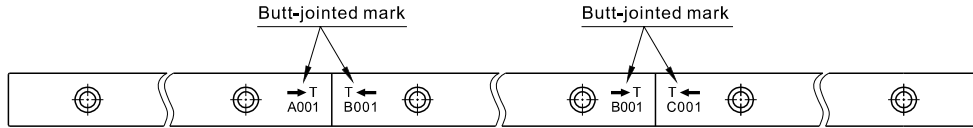

- When jointing rails, it must follow group marks on rail to ensure the accuracy of linear guide. These marks are located on the top surface at joint side. Please put the same group marks together.

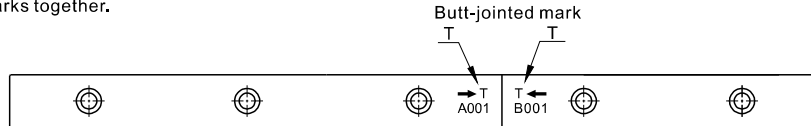

- Be aware serial number of group mark when assemble. A001 and B001 are in a group, so as to A002 and B002 and so on.
- Be aware the installation direction while assembly, the serial numbers are not upside down and arrows point to each other.

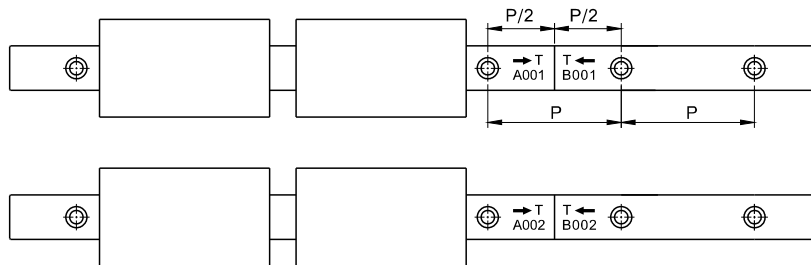

13. Measurement Method after Installation

When measuring running accuracy of the block, two blocks should be fixed on an inspection table in close contact to obtain stable accuracy. When using a dial gauge, a provisional benchmark (like a straight-edge) is recommended to put as close as possible to the block for accurate measurement.

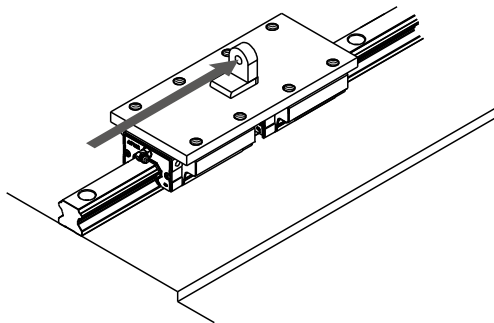

Method using an autocollimator

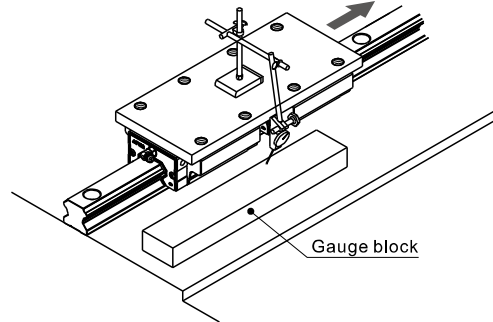

Method using a dial gauge

Low Profile Type Linear Guide

LSD Series

Lubrication method

When a linear guide is well lubricated, it can reduce wear and increase lifespan significantly. Lubrication has the following benefits :

- Reduces friction of the rollers and raceway to minimize wear.
- The grease film between contact surface can prevent roller fatigue.
- Prevent rust.

1. Lubrication Grease

Use the correct grade of lubrication. While lubricating, a grease gun can be used to pump grease into slider through the grease nipple on it. The suitable condition for lube is when working speed is under 60 m/min and not in cooling process.

•Nipple type

	L-P-M4	L-P-M6	L-P-SM6
Grease nipple type	<p>LSD15 M4X0.7P</p>	<p>LSD20 LSD25 LSD30 LSD35 M6X0.75P</p>	<p>LSD20 LSD25 LSD30 LSD35 M6X0.75P</p>

•Grease amount

LSD series linear guide is well lubricated with 'Shell Alvania grease S2' in factory. Customers are recommended to use identical or the same grade of lubricant. After lubrication, block needs to be moved back and forth at least three times for the length of three blocks and repeat at least twice. Check if the surface of rail is well covered by grease film.

Model	Grease amount for the first lubrication(cm ³)		Replenishment amount(cm ³)	
	Short type	Standard type	Short type	Standard type
LSD15	0.5	0.9	0.2	0.3
LSD20	1.1	1.8	0.4	0.6
LSD25	1.8	3.2	0.6	1.0
LSD30	2.9	4.5	0.9	1.4
LSD35	4.1	5.9	1.3	1.8

•Lubrication frequency

Although the linear guides are well lubricated at factory and retains grease well, frequent lubrication is still necessary to avoid undesirable wear. Recommended lubrication period is every 100km of movement or every 3~6 months. (Refer to table on the top for suggested amount)

2. Lubricating oil

Recommended oil viscosity for lubrication use is about 30 to 150 cst.

Lubrication oil is suitable for all kinds of load and impact application, but not for high temperature use due to its tendency of vaporization.

•Adaptor

L-P-AM6	L-P-AM8	L-P-A01	
<p>LSD15</p>	<p>LSD35 LSD30 LSD25 LSD20</p>	<p>LSD35 LSD30 LSD25 LSD20</p>	
L-P-LM6	L-P-LM8	L-P-L01	L-P-LM8-P2
<p>LSD15</p>	<p>LSD35 LSD30 LSD25 LSD20</p>	<p>LSD35 LSD30 LSD25 LSD20</p>	<p>LSD35 LSD30 LSD25 LSD20</p>

Note: After installation, the top surface of adaptor may be higher than block. Be careful about the interference while moving.

Low Profile Type Linear Guide

LSD Series

Lubrication method

Oil supply rate

Loss of lubrication oil is faster than lubrication grease. Pay attention to sufficiency of oil while using.

Model	Oil amount for the first lubrication(cm ³)	Feeding Speed(cm ³ /hr)
LSD15	0.3	0.1
LSD20	0.5	0.15
LSD25	0.6	0.2
LSD30	0.8	0.25
LSD35	0.9	0.3

3. Grease nipple/adaptor installation

- Grease nipple or adaptor can be installed in the two sides of block for manual or automatic lubrication based on customer's requirement.
- There are a secondary set of lubricating ports on the side of the block. When using, it is not recommended to use the side with datum line unless necessary.
- Lateral nipple installation is not recommended for flange type blocks. (The grease / oil nipple may interfere with block)
- If lateral lubrication is needed for above spec, please contact us for customization.

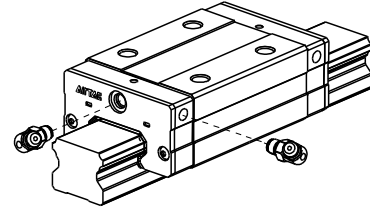

Bolt hole plug

1. Plug type

In order to prevent metal swarf or external objects from entering blocks and affecting precision and lifespan, customers must put plugs into holes during installation. Every rail is equipped with default plugs.

Model	Bolt	Diameter(D)(mm)	Thickness(H)(mm)
LSD15	M3	6.15	1.2
	M4	8.15	1.1
LSD20	M5	9.65	2.5
LSD25	M6	11.4	2.5
LSD30	M6	11.4	2.5
	M8	14.4	3.5
LSD35	M8	14.4	3.5

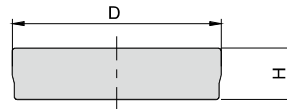

2. Plug installation Steps

Step one



Place the plug in counterbore.

Step two

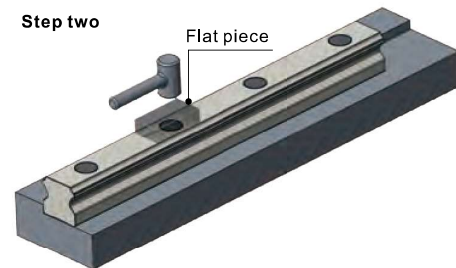

Place the flat piece on mounting hole, hit the piece vertically with a plastic hammer and fix the plug into counterbore.

Note :

- Please make sure the plugs do not protrude the rail surface.
- After installation, please clean the surface before use.

Low Profile Type Linear Guide

LSD Series

Dust prevention illustration

1. Code and structure

AirTAC provides the following dust prevention accessories for the linear guides working in dusty environment, if the following accessories are demanded, please add the corresponding code when ordering.

Code	Blank: Standard	DD: Double oil scrapers	ZZ: Metal scraper + Oil scraper
Structure	<p>Top seal Side seal Oil scraper</p>	<p>Top seal Side seal (Enhanced) Double oil scrapers (Double lips, enhanced)</p>	<p>Top seal Side seal (Enhanced) oil scrapers (Double lips, enhanced) Metal scraper</p>

2. Test for high dust prevention

2.1. Test item

Test medium	Wood chip	Iron filing	Gravel
Running distance	500km	500km	500km

2.2. Test equipment

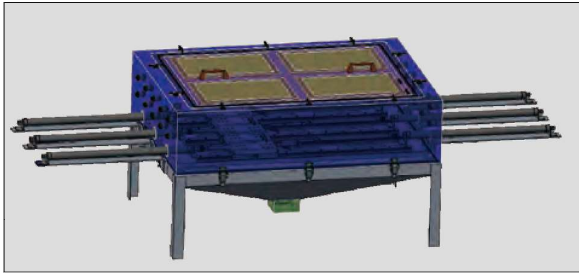

Figure1: Dust tester (Appearance)



Figure2: Dust tester (Inside)

2.3. Test condition

AirTAC adopts the industry's first dust tester (Figure 1) to simulate real working conditions, 360° without dead angles, all-round dust invasion (Figure 2). The dustproof test simulates multiple application scenarios, fully fill the air with wood chips, iron filings and gravels and are strictly tested to ensure the quality and dustproof effect of each block.

2.4. Test result



Figure3: Steel balls



Figure4: Steel balls

Result: It can be seen from the Figure 3 and 4 that little amount of dust enters the inside of the block after testing, and the steel ball surface is still smooth, the block still runs smoothly and the performance is not affected.

Note: The above test results are obtained from AirTAC lab.

3. Dimensions

Highly dustproof type blocks have different length compared with the standard blocks (only dimension C is different from the standard, the others keep same), see the table on the right for details.

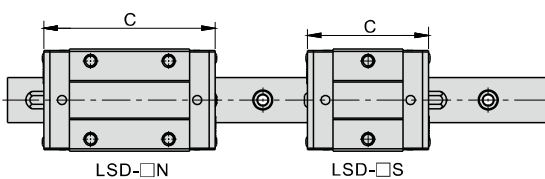

Model	Type	Length C (mm)		
		Standard (Blank)	Double oil scrapers(DD)	Oil scraper+Metal scraper(ZZ)
LSD15□S	Short	40.5	47.5	45
LSD15□N	Standard	57	64	61.5
LSD20□S	Short	46	53	50.5
LSD20□N	Standard	65	72	69.5
LSD25□S	Short	59	66	63.5
LSD25□N	Standard	83	90	87.5
LSD30□S	Short	68.5	76.5	73.5
LSD30□N	Standard	97	105	102
LSD35□S	Short	73.5	81.5	78.5
LSD35□N	Standard	106.5	114.5	111.5

Low Profile Type Linear Guide

LSD Series

Precautions on use

1. Block disassembly

With ball retainers and a dustproof cover, normally the balls are prevented from falling out when block is removed from rail. However, if obliquely insert rail into blocks or quickly assembled or disassembled, there is a risk for balls of falling out. Please carefully assemble the linear guide or use plastic rails to assist.

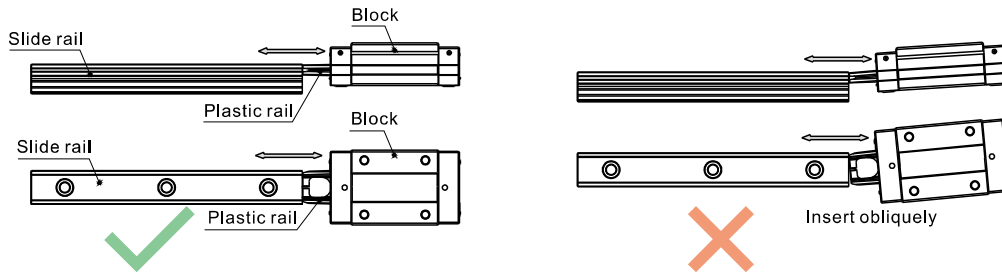

2. Plastic rail installation

A plastic rail is equipped for block set. Please do not remove plastic rail whenever it is not necessary. If plastic rail falls out and needs to be reinstalled, press the dustproof covers with fingers and install slowly to prevent balls from falling out due to misalignment of plastic rail.

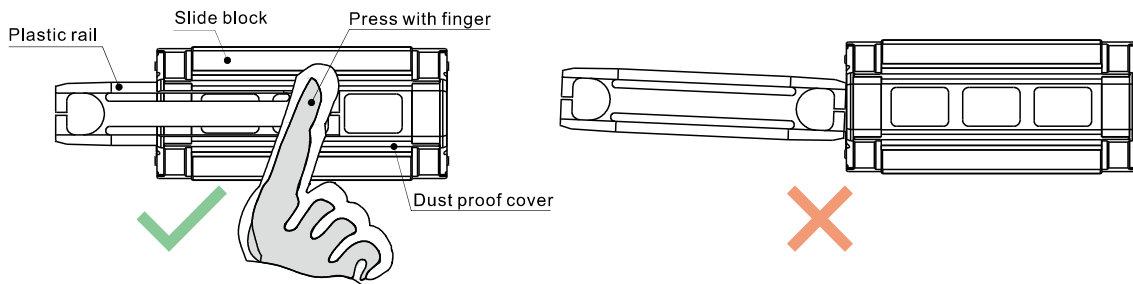

Press the dust-proof covers and insert plastic rail in alignment.

Without pressing dust-proof covers or insert plastic rail obliquely.

3. Caution

- Parts may slide out if linear guide is put unevenly. Please be careful.
- Hitting or dropping linear guide could have huge effect on accuracy and lifespan even though appearance may remain intact. Please be careful.
- Do not disassemble linear guide as external objects may enter blocks and cause accuracy problem.

4. Lubrication

- Linear guide have been treated with anti-rust oil during production. Before use, wipe the rail and treat it with lubrication.
- Do not mix lubricating oil (grease) with different properties.
- After lubrication, move block back and forth for the length of three blocks long and repeat at least 2 times to ensure there is a grease file on rail.

5. Use

- The operating environment temperature should not exceed 80°C, and the maximum temperature should not exceed 100°C.
- Do not separate blocks from rail whenever it is not necessary. If you need to separate them, please use plastic rails to prevent steel balls from falling out.

6. Storage

- When storing blocks, rails or linear guide set, please be sure that anti-rust oil is well applied and product is well sealed as well as placed horizontally. Avoid humidity and high temperatures environment.